

Data Sheet



Article number: 201055281

Description: E+G Handwheel
GN 949-100-B12-A

Measures

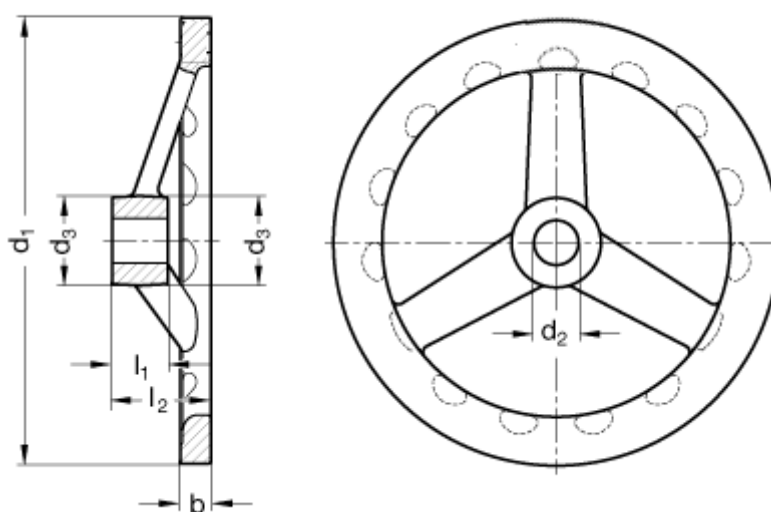

A/F = 9

b = 7

d1 = 100

d2 = 12

d3 = 20

l1 = 15

l2 = 27,5

l3 = 45

Number of spokes = 3